

0497 212

OPERATING MANUAL



MODEL CE

CAPACITOR EXAM-ETER

SER. + E - 7248

SOLAR MANUFACTURING CORPORATION

NEW YORK, N. Y.

7-8-70

OPERATING MANUAL

MODEL CE CAPACITOR EXAMINER

This edition applies to serial numbers starting at 70,160.

The EXAMINER is more than an analyzer. It EXAMINES electrical condensers for every feature relating to quality and performance. Results are prompt and certain.

MODEL CE-1-60 CAPACITOR EXAMINER POWER LINE CONNECTIONS

The Solar Model CE-1-60 Capacitor Exam-ster is designed for use on 110-volt 50-60 cycles. It should not be connected to power lines which supply other voltages or frequencies. Proceed with measurements according to instructions described in this manual.

MODEL CE-2-U CAPACITOR EXAMINER POWER LINE CONNECTIONS

The Solar Model CE-2-U is a universal instrument which can be operated from power lines rated at 120, 165 or 240 volts, 25 to 60 cycles.

To place the Capacitor Exam-ster into operation remove the small metal plate in the back of the cabinet and insert the plug in the jack corresponding with the available line voltage.

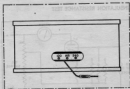

OPERATING INSTRUCTIONS SOLAR CAPACITOR EXAMINER

Model CE-1-60 110-volts 50-60 cycles
Model CE-2-U 120, 165, 240 volts 25-60 cycles

GENERAL

The Solar Capacitor Exam-ster provides service men and laboratories with an analyzer that combines in one instrument a convenient and simple method of mak-

ing a complete analysis of condensers under either static or dynamic conditions of operation.

The performance characteristics of radio and video receivers have imposed requirements which can be maintained only by the use of high quality component parts. These parts, especially condensers and resistors, must have the proper electrical characteristics to perform their designated functions properly. If satisfactory results are to be obtained from receivers.

Condensers have a detrimental effect on reception long before they become entirely defective. The problem of determining the quality or operating efficiency of a condenser requires a complete analysis of its contents.

In this instrument condensers may be tested for capacity, leakage, insulation resistance, power factor, opens, shorts, intermittents, and R.F. impedance. Also with the full development of the quick-check features plus the bridge-meter, we find it possible to present an instrument which will give every qualitative and quantitative measurement of capacitors necessary in modern servicing by means of a simple meter reading. It tells the complete performance story of all types of paper, mica, electrolytic, trimmer and air condensers. Checking for quality is done under conditions of either static or dynamic performance; the condenser under test may be operating in a circuit, or it may be disconnected.

In addition a vacuum tube voltmeter is provided for measurements of circuit voltage to determine the required voltage rating of the condenser under test.

The V.T. voltmeter can be used for slipping R.F. circuits, checking A.C. voltages, and checking output levels and signal voltages at various points throughout the receiver.

Accurately calibrated markings on the panel are provided for convenient measurements of capacity and resistance. These tests are made on a Wien Bridge with six direct reading ranges, by multiplying the scale reading by the bridge constant. The power factor of electrolytic condensers including A.C. or motor starting types can be read directly from a scale which is calibrated zero to 50% power factor. The capacity range of the instrument is from .0001 mfd. to 2000 mfd., the resistance range from 50 ohms to 10,000 megohms. A meter is used as a null indicator. This change from our previous null indicator for which an electric eye was employed, has been made to provide greater sensitivity and an easier and more positive balance.

Only two terminals are used for all condensers and resistance measurements. There are three other terminals on the panel which are used when making external

voltage measurements. The switch within the Capacitor Easster automatically connects the unit under test into the proper circuit.

The leakage test section of the instrument consists of a variable source of D.C. voltage and a meter. The leakage is read directly on a D.C. milliammeter. A leakage current up to 50 milliamperes can be measured along with the actual D.C. voltage impressed on the capacitor. No switching from top to top is necessary as a continuously variable D.C. voltage can be obtained from 0 to 500 volts. This makes it possible to form up electrolytic capacitors of any rating up to 500 volts. By special regulation of the leakage circuit the meter when set on the 50 ma. range is protected against damage due to overloads caused by shorts and high leakage electrolytics.

The megohm range of the instrument is particularly useful for the measurements of insulation resistance on paper and mica condensers. It is especially useful in detecting faulty coupling condensers. The instrument provides direct and positive means of making measurements as the meter dial is accurately calibrated in megohms.

The sensitivity of the instrument is high and will be found useful for tests on insulating materials, and parts such as terminal boards.

The range covered by this part of the instrument is from 1 megohm to 10,000 megohms in three separate ranges.

The Quick-Check features of the Solar Model QCA and QC are incorporated in this instrument. The Quick-Check section consists essentially of a complex balanced radio frequency oscillator, a visual indicator in the form of a sensitive milliammeter, and a source of power. The oscillator system is arranged to permit easy and positive determination of capacity quality under static or dynamic conditions. The condenser under test may be operating in a circuit, or it may be disconnected. The Quick-Check section determines spurious inductances, shorts, R.F. impedance and high power factor.

The instructions to follow specify certain limits which have been set as standards to be used as a guide in judging satisfactory condensers. These limits were set originally on the basis of our years of experience with condensers. In general, condensers which meet these specifications will be found satisfactory in operation, while those rejected will interfere with satisfactory operation of the circuit in which they are used.

On the other hand, it is well known that condensers used in certain specific circuits may be more or possibly less critical with respect to their electrical constants than

our limits indicate. These exceptional cases can be handled best by intelligent use of the Capacitor Easster after careful and thorough study of all the accompanying instructions.

CAUTION: Do not remove or leave the bridge control knob, since this is carefully set during calibration of the factory.

OPERATING INSTRUCTIONS

QUANTITATIVE MEASUREMENTS

In order to make quantitative measurements at least one terminal of the condenser must be disconnected from the circuit, or the condenser may be entirely disconnected.

To make the instrument ready for test, the following procedure should be followed:

1. Insert the test leads, with the rubber protection over the clips, into the tip jacks marked "Cond. Test." The red plug should be connected into the red tip jack and the black plug into the black tip jack to obtain the correct polarity.
2. Set the selector switch on the desired range.
3. Connect the line plug to the power outlet and turn on the voltage control switch. Allow about one minute for the tubes to heat up and then proceed with the testing as described below.

INSULATION RESISTANCE TEST

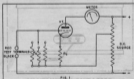

A simplified circuit diagram showing the insulation resistance test circuit is given in Fig. 1. This circuit consists of a D.C. source of voltage, a vacuum tube voltmeter, and a milliammeter calibrated in megohms. A leakage current flowing through the condenser under test will develop a voltage across "Rc" which is impressed as a negative bias across the grid of the V.T. causing a decrease in the plate current. The change in plate current caused by the leakage of the condenser is shown

directly on the meter scale in terms of megohms.

To make the instrument ready for insulation resistance tests proceed as follows:

1. Set the selector switch on position M1 (See chart below).
2. Switch the meter to the 5 ma. range.
3. Adjust the voltage control so that the meter reads infinity (∞) which is the null position.
4. Connect the test leads, with the rubber protections over the clips, across the condenser under examination and read the meter deflection, which is given directly in megohms. On low capacity units (leakage resistances), the reading can be taken almost immediately; on higher capacity units it will be necessary to wait until the condenser becomes charged and the meter deflection comes to rest; this may take about 1 minute for a 1 mfd. capacitor. The difference in time between low and high capacity condensers is due to the difference in the charging rate. The high capacity condenser takes longer to charge.

Selector Setting	Insulation Resistance in Megohms	Multiply Scale by
MX 1	3 to 100 megohms	1
MX 10	30 to 1000 megohms	10
MX 100	300 to 10000 megohms	100

If the meter deflection is greater than 100 megohms on range MX 1, set selector switch on position MX 10 and, if it is still greater than 100 on this range, set the selector switch on range MX 100, the next highest setting.

SATISFACTORY — Insulation values greater than 50 megohms. (See note below.)

LEAKY — Insulation values less than 50 megohms. (Replace condenser.)

SHORTED OR LESS THAN 3 MEGOHMS — Meter deflection reads zero. (Replace condenser.)

OPEN — No variation in the meter deflection. (Replace condenser.)

The leakage check on paper, mica, blimmer, and all solid dielectric condensers is made in the manner described.

NOTE — The insulation resistance of 50 megohms will be found satisfactory for most applications with the exception of coupling condensers. In the case of coupling condensers the insulation resistance should be above 200 megohms.

Values of resistors greater than 3 megohms can be tested on this range. The checks are made in the manner described above.

LEAKAGE TESTS ON ELECTROLYTIC CONDENSERS

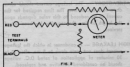

Figure 2 is a simplified circuit diagram of the electrolytic leakage test circuit. The desired D.C. voltage, selected by varying the voltage control, is impressed across the condenser under examination. The leakage current is read directly in milliamperes from a meter in series with the condenser and the voltage impressed across the condenser is obtained by depressing button marked "volt".

To make the instrument ready for a leakage test on an electrolytic condenser proceed as follows:

1. Set the selector switch on position "L".
2. Switch the meter to the 50 mA. range.
3. Adjust the voltage control to a low voltage position. (Indicator knob rotated to left.)
4. Connect the test leads, with the rubber protectors over the clips, across the condenser under examination, the red lead connected to the positive side of the condenser and the black lead to the negative.
5. Now depress button marked "volt" and rotate the voltage control knob until the voltmeter indicates the voltage at which the condenser is to be checked. This check is normally made at the rated working voltage of the condenser.
6. Now release the voltage button and read the leakage current directly in milliamperes on the meter. If the leakage current is less than 5 ma. switch the meter from the 50 ma. range to the 5 ma. range so that the leakage current can be read more easily. When making this test always keep the milliammeter on the 50 ma. range except when actually taking readings. The reason

for this is that it is impossible to damage the meter when it is adjusted for the high current range because the instrument has been designed to prevent excess current from damaging the meter element.

SATISFACTORY — The leakage current should come down to 5 ma. or less. The time required for the current to be reduced to this value depends upon the length of time the capacitor has been out of service.

HIGH LEAKAGE — A condenser in which the leakage current does not come down to 5 ma. after 20 to 30 minutes of application of rated D.C. voltage should be considered defective and replaced.

SHORTED — Appreciable flickering in the leakage current. (Replace condenser).

Tests of electrolytic condensers that have been out of service for long periods of time may be speeded up by continued adjustment of the voltage so that it is kept at the initial setting of the test voltage.

For example as the leakage current is reduced the D.C. test voltage will have a tendency to increase resulting in an increase in the leakage current. Reducing the test voltage to the rated value will reduce the leakage current proportional to the reduction in voltage. It sometimes happens when the condenser has been out of service 15 to 20 months that it is more convenient to start with a D.C. voltage less than rating not sufficient to give 40 to 50 milliamperes and to increase the voltage as the current is decreased up to rated voltage. When rated voltage is reached proceed as described above.

CAPACITY OF PAPER, MICA, TRIMMER, ELECTROLYTIC AND AIR CONDENSERS POWER FACTOR OF ELECTROLYTICS

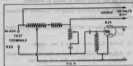
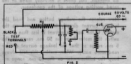

A circuit diagram of the section of the Capacitor Tester used in capacitance measurements on the "C/R" scale is shown in Figure 3 and for capacitance measurements on the "H" scale in Figure 4.

The test section is a special Wheat Bridge which consists of potentiometer "R2", standard capacitors C1, C2, C3 and the unknown capacitor connected across the test terminals. The 40 cycle source voltage is obtained from a winding on the power transformer. The detector employed to indicate balance consists of a sensitive V.T. voltmeter with a millimeter in the plate circuit used as a null indicator.

To make the instrument ready for capacity and power factor checks, proceed as follows:

1. Set the selector switch on the position corresponding with the capacity value of the condenser being tested, as described below:

Capacity Range	Set Selector Switch at	Multiply Scale by
.00001 to .0001 mfd.	CX .0001	.0001
.001 to .01 mfd.	CX .01	.01
.10 to .50 mfd.	CX 1	1.0
.50 to 2000 mfd.	HX 1	1.0

(For CX switch settings, read capacity on C/R scale; for HX settings, read on H scale.)

2. Switch the meter to the 5 ma. range.
3. Connect the test leads, with the rubber protection over the clips, across the condenser under examination.
4. Adjust the voltage control to approximately 450 on the voltage control dial.
5. Now rotate the capacity control slowly from right to left until maximum deflection is obtained on the meter. This is the "balance position". Capacity readings are shown directly on the calibrated scale of the instrument.

For electrolytic condensers, balance the capacity control as described above, and then adjust the Power Factor Control for the maximum meter deflection.** Then read the power factor directly from the scale. In this check the voltage control setting is not critical at all and may be adjusted to any desired value to give a readable deflection of the meter.

If adjusted for a high deflection the instrument is more sensitive than when adjusted for a low deflection.

**Note: It is often desirable to rebalance the capacitor control after the power factor adjustment has been made.

OFF CAPACITY — Condensers which measure more than 20% lower than rated capacity should be replaced by units of the correct value. For bypass and filter use no limit need generally be placed on the upper capacity limit. Special cases will be considered later.

The capacity of A.C. motor starting electrolytic condensers should be within $\pm 20\%$ of rated value for satisfactory operation. However, a slightly greater tolerance is permissible in some cases.

OPENS — Any condenser which can be balanced only at "open" on the capacity scale, after careful adjustments have been made with the selector switch in positions CX .0001, CX .01, CX 1, and HX 1, are open and should be replaced.

INTERMITTENTS — An intermittent will be indicated by a noticeable flickering of the meter needle. Replace condenser.

HIGH POWER FACTOR — Any condenser for which a balance is not obtained on any position of the power factor control should be replaced. For A.C. and motor starting electrolytic condensers, power factors above 20% generally are unsatisfactory. Such condensers should be replaced.

SHORTED — Shorted condensers will balance on the "short" position of the capacity control for any setting of the selector switch if shorted solidly. There will be no balance obtained if the short is high resistance. Shorted condensers will show up on the leakage test as well.

In testing condensers of low capacity, about .001 mfd. and below, the leads to the condenser must be kept short. Best results will be obtained by plugging the ends of the condenser leads directly into the top jacks. This is shown in Figure 5.

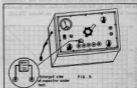

For ordinary filter use, condensers for which a complete balance may be obtained on any setting of the power factor control will generally be satisfactory, especially in the case of high voltage electrolytic condensers.

The tabulation below indicates the filtering efficiency of condensers with various power factors.

POWER FACTOR FILTERING EFFICIENCY

5%	.999
10%	.996
15%	.989
20%	.980
25%	.968
30%	.953
35%	.935
40%	.915
45%	.893
50%	.867
60%	.800
70%	.715
80%	.600
90%	.434
100%	0

POWER FACTOR CORRECTION FOR LINE FREQUENCY

The power factor scale of the analyzer is calibrated for measurement at 60 cycles. The expert model CE-2-U is designated for operation at frequencies from 25 to 65 cycles. The chart in Figure 4 shows the correction to be applied to the measured values when the measurement is made at 25 and 40 cycles on Model CE-2-U.

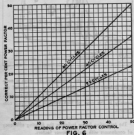

RESISTANCE TESTS FOR ALL TYPES OF RESISTORS

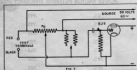

A simplified circuit diagram of the section of the Capacitor Beam-ster used in resistance measurements on the "C/R" scale is shown in Figure 5.

The test section is a conventional Wien Bridge which consists of potentiometer R2, standard resistors R3, R4 and the unknown resistor connected across the test terminals. The 60 cycle voltage supply is obtained from a winding on the power transformer. The detector employed to indicate balance consists of a sensitive vacuum

tube voltmeter with a milliammeter in the plate circuit used as a null indicator.

To make the instrument ready for resistance measurements proceed as follows:

1. Set the selector switch on the position corresponding to the resistance value of the resistance being checked as described below.

Resistance Range	Set Selector Switch at	Multiply C/R Scale by
50 to 75,000 ohms	RX 1000	1000
5000 to 7,500,000 ohms	RX 100,000	100,000

2. Set the power factor control on zero position by revolving the indicator knob to the extreme left.
3. Switch the meter to the 5 ma. range.
4. Connect the test leads, with the rubber protectors over the clips, across the resistance under test.
5. Adjust the voltage control to approximately 410 on the voltage control dial.
6. Now rotate the large center control dial slowly from left to right until maximum deflection is obtained on the meter. This is balance position. Resistance readings are taken directly.

For values of resistance above 7,500,000 ohms, use the insulation resistance section of the instrument. See as per the instructions given in that section. Resistance values of 1 megohms to 10,000 megohms can be measured with the insulation resistance section of the instrument.

D.C. VACUUM TUBE VOLTMETER

The D.C. V.T. voltmeter is used when external voltage measurements are desired. It is used in the same manner as any ordinary voltmeter. On the 500 volt range the voltmeter has an input resistance of 10,000 ohms per volt, on the 50 volt range an input resistance of 100,000 ohms per volt, and on the 10 volt range an input resistance of 500,000 ohms per volt. Measurements are obtained through separate input terminals and the voltage indications are given directly on the meter scale.

To make the instrument ready for voltage checks, proceed as follows:

1. Set the selector switch on the desired position as given in the following chart.

Selector Setting	Voltage Range on Meter Scale
MX 1	0-500 volts
MX 10	0-50 volts
MX 100	0-10 volts

2. Insert the test leads, with the rubber protectors over the clips, into the tip jacks marked "D.C. volts". The red plug should be connected to the red jack and the black plug to black jack to obtain the correct polarity.

1. Switch the meter to the 5 milliamperes range.
4. Adjust the voltage control so that the meter reads "0" on scale V.D.C. This is the null point.
5. Now connect the test leads across the voltage to be measured and read the meter deflection which is given directly in volts.

A.C. VACUUM TUBE VOLTMETER

The A.C. V.T. voltmeter is used as an output indicator for circuit alignment. The voltmeter has an input resistance of 15 megohms and has a range of 10 to 50 volts D.C. To make the instrument ready for voltage checks, proceed as follows:

1. Set the selector switch on position M01 100.
2. Insert the test leads, with the rubber protectors over the clips, into the tip jacks marked "A.C. volts".
3. Switch the meter to the 5 ma. range.
4. Adjust the voltage control so that the meter reads 5 ma. This is the null point.
5. Now connect the test leads across the voltage to be measured and read the meter deflection which is given in milliamperes.

To obtain the voltage measured refer to Figure 8.

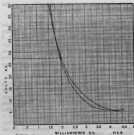

MSE RED CURVE FOR INSTRUMENT

SERIAL # E - 7248.

NOTE: To use this chart the measured value of milliamperes is located at the bottom of the chart. This milliamperes reading is extended vertically to the position where it intersects with the curve corresponding to the position of the selector switch. From this point of intersection extend the reading horizontally to the voltmeter scale. This shows the value of the measured voltage. (See dotted line for example.)

Continuity checks may be performed with this test instrument. One method of procedure makes use of the leakage check feature of this instrument.

To make this check:

1. Set the selector switch on position "L".
2. Switch the meter to the 50 ma. range.
3. Adjust the voltage control to a low voltage position. (Indicator knob rotated to left.)
4. Insert the test leads, with the rubber protectors over the clips, in the tip jacks marked "Cond. Test".
5. Now short the ends of the test clips together and adjust the voltage control until the milliammeter reads about 10 milliamperes.
4. Disconnect the shorted test clips. The instrument is now ready for continuity checks.

In making this test, the test clips are connected across the circuit or circuit element under examination. If there is a complete circuit the meter will give a reading. If the circuit is open there will be no meter reading.

The milliammeter is adjusted to 10 milliamperes under short circuit conditions so that the instrument will not be overheated under prolonged short circuited tests.

If a more sensitive indication is desired, set the milliamperes meter on the 5 ma. range and adjust the voltage control so that the meter reads approximately 4 milliamperes. Under this condition the meter is not protected if the voltage control adjustment happens to be accidentally increased and therefore it is not advisable to use this 5 ma. range except in special cases where a more sensitive indication is desired.

OPERATING INSTRUCTIONS FOR "QUICK-CHECK" SECTION

QUALITATIVE MEASUREMENTS

With qualitative checking it is not necessary to disconnect the condenser from the circuit. The condenser under examination can be checked in the set under actual operating conditions with the set switched on, or with the set switched off, or with the condenser disconnected from the circuit if desired, although this is not necessary. The instrument is so designed that the indication is definite and instantaneous even though the condenser is shunted by an inductance or resistance. These factors do not detract from the accuracy of the measurements.

The range of the "Quick-Check" section is from 75 μ mf. to 50 mfd.

To make the instrument ready for test, the following procedure should be followed:

1. Set the selector switch on the position marked "D".
2. Insert the special twin condenser Quick-Check test leads into the tip jacks marked "Condenser Test". The red plug should be connected into the red jack and the black plug into the black jack.
3. Switch the meter to the 5 ma. range.
4. Adjust the voltage control so that the meter reads 5 ma. This is the null position.
5. Revolve the capacity dial to the extreme right on "Short" position.

The instrument is now ready to be used in making tests on condensers. The tests should be made in the following order:

1. Test for opens or intermittently open condensers.
2. Test for shorts or intermittently shorted condensers.
3. Test for high R.F. impedance and high power factor on electrolytic condensers.

Now connect the Quick-Check leads across the condenser under examination. The black test lead should be connected to the point nearest ground.

NOTE: The test starts when the test leads are connected across the condenser. This is very important, as one must first watch for test indications at that moment of contact.

OPEN TESTS

If there is no change in the meter reading when the condenser is connected across the test terminals, then the condenser is open. Replace the condenser. Further checks are not necessary. If the condenser is not open the milliammeter reading will change from 5 ma. to a lower value. Open tests can be made even though the condenser is shunted by an inductance or resistance.

INTERMITTENT TESTS

If the meter needle flickers; that is if the milliammeter reading varies back and forth from 5 milliamperes to a lower value, then the condenser has an intermittent connection. Replace the condenser.

A note of caution should be introduced at this point. The operator should be sure that the test leads are securely plugged into the tip jacks and the alligator clips securely fastened to the condenser terminals under test; otherwise, the test may indicate an intermittent condenser when the fault is the result of a poor connection.

SHORT TEST

If the milliammeter reading decreases to a lower value when the test clips are connected across the condenser, this is a positive indication that the condenser is not open. It is now necessary to determine by another test whether the condenser is shorted.

The push buttons marked "L" and "H" are provided for this test. If it is known that the unknown capacity is less than .003 mfd., then depress push button "L". If the capacity is above this value, then depress push button "H". If the meter reading returns to 5 milliamperes, then the condenser is shorted. If the meter reading decreases, remains constant, or increases slightly then the condenser is not shorted.

When the capacity of the condenser under test is not known a double check is necessary. First, depress button "L" and then button "H" and if the condenser is shorted the meter reading will return to 5 milliamperes in each case. If the meter reading does not return to 5 milliamperes in each case, then the condenser is not shorted even though it shows short when one button is depressed. In other words if a condenser is shorted it will show short in both cases.

The short circuit test is effective even though the condenser is shunted by an inductance or resistance.

Make sure that the push buttons are pressed all the way down in making the short test. It sometimes happens that the meter reading will flicker as the push buttons are pressed down. This is a result of changing the internal circuit connections and is not indicative of an intermittent short. When the button is held down and the meter needle flickers, then this is a positive indication that the condenser is intermittently shorted.

SUPPLEMENTARY INFORMATION

Have a word in general about intermittent condensers, supplementing the information previously given for intermittent opens and intermittent shorts.

An intermittent condenser may be the result of a pressure contact only, between the terminals and the condenser surface proper, and this connection will be broken if the unit is subjected to mechanical vibration or temperature changes. It is suggested that the condenser be moved back and forth slightly to show up such pressure contacts.

In case this mechanical test does not show up the fault, the Quick-Check leads can be left connected across the capacitor and the receiver placed in normal operation until it has reached an operating temperature.

If the unit becomes intermittent as a result of temperature, the meter indicator will flicker.

The accuracy of this check will not be affected even if the condenser under test is shunted by an inductance or a resistance.

The Quick-Check offers a convenient method for detecting electrolytic capacitors which have high power factor and high R.F. impedance. It sometimes happens that in checking an electrolytic condenser there will be sufficient capacitance in the circuit to indicate that the unit is okay. However, the power factor will be so high as to make the capacitor perform unsatisfactorily in the circuit.

The power factor check is made by connecting the Quick-Check leads across the electrolytic condenser under test and if the condenser is not open, the meter reading will decrease from 5 ma. to a lower reading. If the pushbutton "L" is then depressed, the meter reading will indicate whether the condenser has a high power

factor or not. If the meter reading does not return to 5 milliamperes when the button is depressed, then the condenser is defective. It has either a high power factor or high R.F. impedance or both.

If the condenser is then shunted with a .1 mfd. tubular paper condenser and as a result the circuit disturbance is cleared up, this is an indication of high R.F. impedance. If the circuit disturbance is not cleared up, and particularly if high hum is noted, then the capacitor has high power factor. In either case, the capacitor should be replaced. A further check is to measure the capacitance with the Wien bridge and if the value is substantially below the capacitance stamped on the case, this is a further indication of an unsatisfactory unit.

In certain cases some electrolytic condensers and filter type paper units show up as opens (no change in meter deflection when condenser is connected across) when they are actually okay. This is due to the fact that the inductance of these condensers is particularly high. Condensers with long leads will have comparatively high inductance values. Also, certain condensers due to their construction have inherently high inductance values. Therefore, in order to properly check these types of condensers, it is necessary to make quantitative measurements as well as qualitative checks.

Condensers with high values of inductance are not necessarily defective. They may or may not cause instability depending upon the circuit design in which they are used. This will have to be left to the judgment of the person making the checks.

When using the Quick-Check section of the instrument, indications are given by the variation in the meter deflection and not by the magnitude of the deflection.

When working on various sets there will be a difference in the magnitude of the meter deflection from one set to the other when one side of the condenser is connected to the chassis. The magnitude of the deflection plays no part in the testing of the condenser as indication of quality is given only by the variation in the meter deflection. The difference in magnitude of the meter deflection from set to set is due to the variation in impedance from chassis to ground.

If a case occurs in which no meter deflection is given when the test leads are connected across a condenser that is grounded to the chassis, the analyzer is then out of adjustment.

NOTE: The instrument should never be grounded for dynamic checking.

It is important to realize that if "Quick-Check" qualitative tests are run first, it will often be necessary to make the more tedious quantitative checks, as defective units often may thus be spotted without disconnecting them.

READJUSTMENT OF THE QUICK-CHECK SECTION OF THE MODEL CE EXAM-ETER

Due to rough handling in shipment, the Quick-Check section of the Capacitor Exam-eter sometimes goes out of adjustment. Improper adjustment will be indicated by one or more of the following conditions.

1. It is impossible to set the meter on the null position. The meter will give an indication somewhat less than 5.0 ma. even when the voltage control is set at maximum.
2. When the meter is adjusted to the null position (5.0 ma.) it will indicate a value slightly greater than 5.0 ma. when either one of the test leads are grounded or touched by the hand.
3. Lack of sensitivity; that is, the instrument will give no indication on low capacities. The Quick-Check circuit should check all capacities from 75 mfd. and above.

The Quick-Check circuit of the analyzer can be readjusted very simply. The procedure to be followed for readjustment is as follows:

1. Set the analyzer for dynamic checking and insert the test leads into the slip jacks. Do not short the test clips together. Now take the "red" test clip in one hand and adjust the voltage control so that meter deflection is 5.0 ma.
2. Now release the red test lead and adjust the trimmer control through the hole in the side of the case just below the condenser test terminals to the point where the meter deflection changes sharply from a value less than 5.0 ma. to 5.0 ma.

Proper adjustment of the analyzer will be realized when the following conditions are fulfilled:

1. First, the meter deflection can be readily set at 5.0 ma. and will not vary when the red test clip is held in the hand.
2. Secondly, the meter reading will decrease from 5.0 ma. to a somewhat lower value when 75 to 100 mfd. condenser is connected across the test clips.

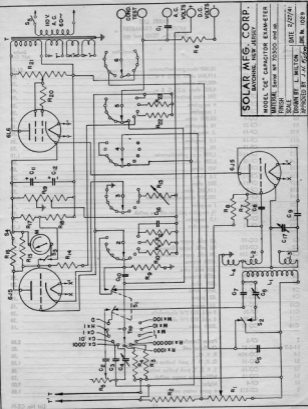

SOLAR MFG. CORP.
 BAYONNE, NEW JERSEY

MODEL "CE" CAPACITOR EXAM-ETER
 WATTAGE: Series set 70000 and in.
 FREQUENCY: 60 cycles per second

DATE: 2/27/41
 SCALE: 1000
 DRAWN BY: L. WILSON
 APPROVED BY: J. W. PETERSON, JR. No. 1029

PARTS LIST
MODEL CE EXAMETER
(Serial No. 70300 and up)

Drawing Symbol	Color Catalog Number	Description	Dials Mill Cost
R1	CD-324	10,000 ohms potentiometer	\$1.10
R2	CF-17	119,500 ohms $\pm 2\%$ 1 w.	.95
R3	CD-349	400,000 ohms	.35
R4	CF-23	4,000 ohms $\pm 2\frac{1}{2}\%$ 5 w.	.65
R5	CF-8	388 ohms potentiometer	.95
R6	CF-16-1	4 megohms	.35
R7	CB-28	1 megohm	.35
R8	CQ-9	50,000 ohms	.15
R9	CB-29	10 megohms	.15
R10	CF-15	.1 megohm	.35
R11	CF-14	1.0 megohm	.35
R12	CF-13	10. megohms	.35
R13	CF-11-1	1,000 ohms potentiometer	1.10
R14	CF-10	5,000 ohms	.50
R15	CF-11-2	500 ohms	.50
R16	CF-12	2.8 ohms	.35
R17	CF-11-2	500 ohms	.50
R18	CF-6	119,500 ohms	.35
R19	CF-7	105,000 ohms voltage divider	1.10
R20	CB-28	1 megohm	.15
R21	CF-6	$\frac{1}{2}$ megohm pot./on-off line switch	.95
R22	CF-14	1.0 megohm	.15
R23	CF-15	.1 megohm	1.10
C1	CQ-10	.01 mfd. paper	.15
C2	CD-333	4.0 mfd. paper, Durolite	1.30
C3	CD-334	.04 mfd. paper, Durolite	.15
C4	CF-19	.0004 trimmer	.35
C5	CQ-13	.001 mfd. mica	.15
C6	CF-19	.0004 trimmer	.35
C7	CQ-26	.005 mica	.30
C8	CQ-13	.0001 mica	.15
C9	CQ-16	.02 paper	.15
C10	CQ-16	.02 paper	.15
C11	CF-30	8 mfd. 350 VYW electrolytic	.30
C12	CF-30	8 mfd. 350 VYW electrolytic	.30
C16	CQ-13	.0001 mica	.15
T	CF-5	Power Transformer	3.30
L1-3-3	CQ-27	Oscillator coil	.85
L4	CQ-30A	R. F. C.	.30
S1	CQ-15	D. P. D. T. push button switch	1.30
S2	CQ-16	S. P. D. T. push button switch	.85
S4	CQ-18	milliampere range switch	.30
M	CF-4	Meter	7.00
S	CD-313	6 gang rotary switch	1.85

CAPA FOR EXAMETER
RESISTANCE-BRIDGE AIR VACUUM TUBE VOLT METER
CE MODELS

This card is to be used as a guide in checking condensers and testers with this instrument. Read the instruction booklet for detailed information.

INSULATION RESISTANCE TESTS

FOR PAPER, WAX, AND TRIMMER CONDENSERS

1. Insert the test leads with the rubber protection into the top leads marked "Lead Test".
2. Set the selector switch on the desired range.
3. Turn the rubber switch on the rubber connector and turn on the voltage control switch and observe the reading on the meter in hand unit.
4. Adjust the meter control to the "1 m.v." range.
5. Adjust the voltage control so that the meter reads "1" and proceed with testing.

Condenser Resistance	Selector Switch	SELECTOR CONTROL	METER
1 to 100 megohms	Switch	Terminal	Scale 10
10 to 1000 megohms	Switch	Control	Scale 100
100 to 10000 megohms	Switch	Control	Scale 1000

REMARKS: Insulation values greater than 99 megohms. Insulation values less than 99 megohms. (Capacitor Coefficient) No provision is made reading on cap coils. (Capacitor Coefficient) Following is the meter reading. (Capacitor Coefficient) Meter reads zero on all ranges. (Capacitor Coefficient)

SHORTED:

LEAKAGE TESTS

ON ELECTROLYTIC CONDENSERS (Capacitor Coefficient)

1. Insert the test leads with the rubber protection into the top leads marked "Lead Test".
2. Turn the rubber switch on the "10 m.v." range.
3. Connect the top plug in the power lead and turn on the voltage control switch. Adjust the top plug in the power lead until the meter reads 99 for the desired range of problem.
4. Turn the rubber switch on problem "10".
5. Turn the top plug around until the voltage control leads and the rubber switch are closed with the condenser to be checked.
6. When voltage control across test leads and proceed with testing.
7. When voltage drop below "9 m.v." control the meter to the "9 m.v." range and the reading is being taken. Switch leads to the "99 m.v." range after testing the unit.

REMARKS: Leakage normal less than "9 m.v." to 10 m.v. (Capacitor Coefficient) Leakage normal greater than "9 m.v." after 10 m.v. (Capacitor Coefficient) A high value of normal does not show a leakage to determine in the second. (Capacitor Coefficient) An appreciable following is meter reading. (Capacitor Coefficient) No provision is made reading. (Capacitor Coefficient)

SHORTED:

CAPACITY TESTS

FOR PAPER, WAX, ELECTROLYTIC, AIR CONDENSERS

1. Insert the test leads with the rubber protection into the top leads marked "Lead Test".
2. Turn the rubber switch on the "9 m.v." range.
3. Turn the top plug in the power lead and turn on the voltage control switch. Adjust the rubber switch to approximately 499 on the voltage control scale.
4. Set the selector switch on the desired range.

Capacity Range	Selector Switch	SELECTOR CONTROL	METER
1000 to 10000 pfd	10	10	Scale 10
100 to 1000 pfd	10	10	Scale 100
10 to 100 pfd	10	10	Scale 1000

REMARKS: Never proceed with testing by reading the capacity control directly from right to left and maximum addition is obtained on the meter due to the balance point. Capacity readings are then taken directly. (For paper and wax condensers keep the paper holder control set at zero. For electrolytic condensers, balance the capacitor control set and the top plug around the scale. (When checking paper holder at frequency other than 99 cycles per second than start down to maximum reading.)

APPROXIMATE: (Capacitor Coefficient) (Capacitor Coefficient) (Capacitor Coefficient) (Capacitor Coefficient) (Capacitor Coefficient) (Capacitor Coefficient) (Capacitor Coefficient) (Capacitor Coefficient) (Capacitor Coefficient) (Capacitor Coefficient)

SHORTED: When a balance can be obtained only on the "999" range, no any setting of the selector switch. (Capacitor Coefficient)

RESISTANCE TESTS

FOR ALL TYPE OF RESISTORS AND RESISTANCE MEASUREMENTS

1. Insert the rubber switch on the "9 m.v." range.
2. Connect the top plug in the power lead and turn on the voltage control switch.
3. Adjust the voltage control to approximately 999 on the voltage control scale.
4. Set the selector switch on the desired range.

Resistance Range	Selector Switch	METER
10 to 1000 ohms	10	Scale 10
1000 to 1000000 ohms	10	Scale 1000
	10	Scale 10000

REMARKS: Set the power factor control on zero position. Never proceed with testing by reading the top plug control directly from right to left and maximum addition is obtained on the meter due to the balance point. Resistance readings are then taken directly.

D.C. V.I. VOLTMETER

(Observe Polarity)

1. Set the selector switch on the desired range.
2. Insert the test leads with the red probe extension into the top jacks marked "D.C. Vohls". Observe polarity.
3. Bring the meter switch to the "9 m.a." range.
4. Connect the line plug to the power outlet and turn on the voltage control switch and allow one minute for the tubes to heat up.
5. Adjust the voltage control so that the meter reads "9 milliamperes". This is the null point.
6. Now connect the test leads across the voltage to be measured and read the meter deflection which is given in milliamperes. In order to obtain the value of the measured voltage corresponding to the milliamperes reading refer to Fig. 8 in the instruction booklet.

Voltage Range	Selector Switching	Voltage Reference	Actual Test Leads
0-600 volts	M x 1	Fig. 8	D.C. Vohls
0-75 volts	M x 10	Fig. 8	D.C. Vohls
0-25 volts	M x 100	Fig. 8	D.C. Vohls

QUICK CHECK DYNAMIC TESTS

FOR PAPER, MICA, ELECTROLYTIC, AIR CONDENSERS

1. Set the selector switch on the position marked "R".
 2. Insert the special quick-check test leads (with conductors) into the top jacks marked "Quick Test". Observe polarity.
 3. Bring the meter switch to the "9 m.a." range.
 4. Connect the line plug to the power outlet and turn on the voltage control switch.
 5. Rotate the rotary dial to the extreme right on "Value" position.
 6. Adjust the voltage control so that the meter reads "9 m.a.". This is the null position.
 7. Proceed with testing by connecting the test leads across the unit under examination. The test starts when the test leads are connected across the condenser under examination.
- The tests should be made in the following order:

OPEN:

No change in meter reading when test leads are connected across condenser. (Explosive condenser)
If the condenser is not open the milliammeter reading will change from "9 m.a." to a lower value.
The meter reads "ELekts". (Explosive condenser).

REIDENTIFIERS:

SHORTED:

The meter is now giving a reading somewhere under "9 m.a."
Depress button "E" for all capacities up to .003 mfd.
Depress button "R" for all capacities above .003 mfd.
If the meter reading returns to "9 m.a." then the condenser is shorted. (Explosive condenser). If the condenser is not shorted, the meter reading will decrease, increase slightly, or remain constant.

POWER FACTOR ON ELECTROLYTICS:

The meter is now giving a reading somewhere under "9 m.a."
Depress button "E".
If the power factor is O.K. the meter reading will return to "9 m.a."
If the meter reading does not increase to "9 m.a." the condenser has a high power factor or high R.F. impedance. (See instruction book) (Explosive condenser).